

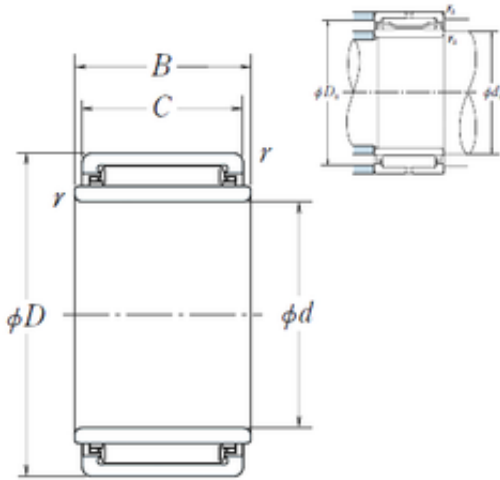

BEARING BOWER CORP.

8 mm x 19 mm x 12,2 mm NSK LM121912
needle roller bearings

Bearing No. LM121912



LM121912 Bearing 2D drawings and 3D CAD models

Size	8x19x12.2 mm
Bore Diameter	8 mm
Outer Diameter	19 mm
Width	12,2 mm
d	8 mm
Fw	12 mm
D	19 mm
B	12,2 mm
C	12 mm
r min.	0,3 mm
da min.	10 mm
Da max.	17 mm
ra max.	0,3 mm
Weight	0,017 Kg
Basic dynamic load rating (C)	7,3 kN
Basic static load rating (C0)	7,15 kN
(Grease) Lubrication Speed	18000 r/min
hidYobi	LM121912
LangID	1
D_	19
B_	12.2
hidTable	ecat_NSMRNR
GRS rpm	18000
ra	0.3
da_min	10



BEARING BOWER CORP.

d2	8
C0	7.15
C1_	12
DE_	17
SLR	8.8
Prod_Type3	NRB_S_LM
DA_	2.5
Z_	10
SI	12
yobi	LM121912
da_max	17
OIL rpm	30000
SDM_	14.5
r	0.3
KBRG	8352
mass2	0.017
B1	12.2