

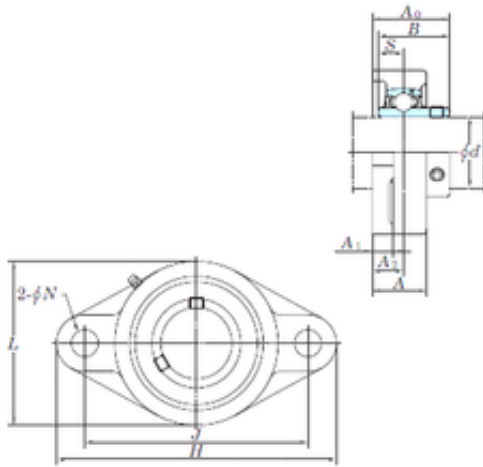

BEARING BOWER CORP.

KOYO UCFL210-30 bearing units

Bearing No. UCFL210-30



Bore Diameter	47,625 mm
d	47,625 mm
A0	54,6 mm
A	40 mm
A1	15 mm
B	51,6 mm
H	197 mm
J	157 mm
L	115 mm
N	19 mm
S	19 mm
A2	22 mm
Weight	2,2 Kg
Basic static load rating (C0)	35,1 kN

UCFL210-30 Bearing 2D drawings and 3D CAD models